



Looks Good



Easy



Smart

We bring wellness
Coway

Coway Customer Service Center

Phone : (213) 386 - 3033

Business Hours :

Monday to Friday from 9am to 6pm

Saturday from 9am to 1pm

Address [U.S. Headquarters] :

695 S. Vermont Ave. #110, Los Angeles, CA 90005

Website : [http:// www.coway-usa.com](http://www.coway-usa.com)

The specification of this appliance may slightly differ from the actual appliance for the enhancement of performance.

Coway

Coway Humidifier Owner's Manual

- This appliance is for U.S. and Canada use only.
- To use our "Coway" humidifier correctly, please read this owner's manual thoroughly.
- This appliance is a household appliance. Do not use outdoors or commercially.

Looks Good 

Easy 

Smart 

English

한국어

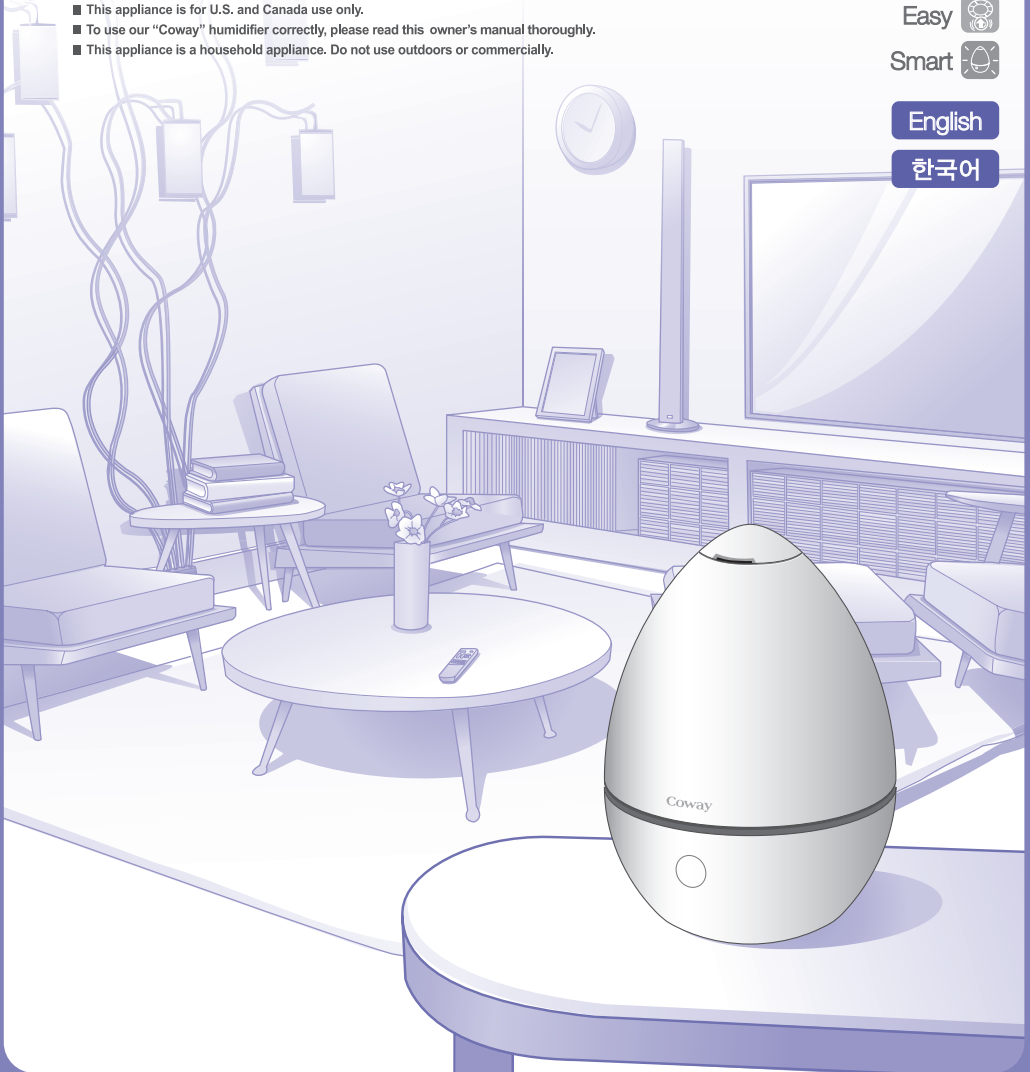

Dear Customers

Thanks for purchasing Coway humidifier. To use and maintain your product correctly, read and retain this manual carefully for future reference. Refer to this manual if any function of your product does not operate normally or if a problem occurs while using your product. Coway is not liable for any damage caused by not following the instructions in this manual.

Precaution

Important safety instructions	02
Features	08

How to use

Parts descriptions	09
Direction for use	10
Control panel instruction	12
Maintenance	13

Troubleshooting

Troubleshooting guide	15
Appliance specifications	16



Precaution







Important safety instructions

Instructions to protect owner's safety and prevent property damage.
Please read and save all instructions before use.

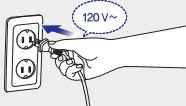
 <p>Danger  Death or critical damage is possible if the instructions are not followed.</p>	 <p>Warning  Considerable injury or property damage is possible if the instructions are not followed.</p>	 <p>Caution  Minor injury or property damage is possible if the instructions are not followed.</p>
---	--	---



For the Power

<p>Danger  This appliance is only for 120V~. Danger of electric shock or fire.</p> 	<p>Do not use a damaged power cord or loose outlet. Danger of electric shock or fire.</p> 
<p>Do not touch power cord with wet hands. Danger of electric shock or fire.</p> 	<p>Do not move your appliance by pulling the power line. Danger of electric shock or fire.</p> 
<p>Remove foreign materials on the power cord. Danger of failure, fire or electric shock.</p> 	<p>Do not connect or alter the power cord on your own authority. Danger of electric shock.</p> 

Precaution

Instructions to protect owner's safety and prevent property damage.
Please read and save all instructions before use.



For the Power



Danger

Do not plug and unplug the power cord repeatedly.
Danger of electric shock or fire.

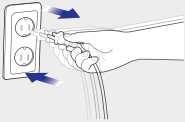

If the power cord is damaged, have it replaced or repaired by its manufacturer, dealer or a qualified technician.
(service staff)

Danger of electric shock or fire.

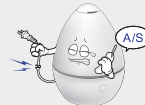

Do not bend the power cord by force or allow it to be crushed or damaged by heavy objects.

Danger of electric shock or fire.



If water enters the power part, unplug the power cord and dry it completely before use.

Danger of electric shock or fire.



Unplug the power cord by pulling the cord.

If you unplug it by pulling the power cord, part of the core line may be disconnected and consequently heat or fire may be generated.



Make sure that the power cord is unplugged when repairing, checking or cleaning the appliance or replacing parts.

Danger of electric shock.



Do not plug several electric appliances in one outlet simultaneously.

Use a dedicated outlet.

Danger of heating, ignition, electric shock or fire.

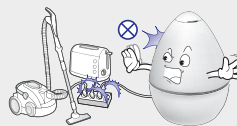



For installation



Warning

Keep the appliance out of reach of children.

Failure to do so may cause fire, electric shock or burning.

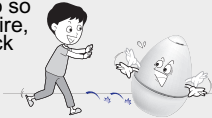

Do not use a damaged water tank.

Doing so may cause fire, electric shock or leakage.



Avoid direct sunlight and avoid installing the appliance near thermal appliances or putting candles or cigarettes on the appliance.

Doing so may cause fire.

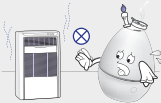

Do not install the appliance in a humid, dusty or wet place.

Doing so may cause electric shock or fire.



Do not put the appliance on glass.

If the glass surface gets wet with water the appliance will slide on the glass and may be damaged or you may get burned.



Caution

Do not install on a slope and do not knock or bang the appliance.

Doing so may cause bodily injury, property damage or leakage.

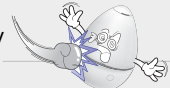

Do not install the appliance close to a wall.

Keep a clear distance of 3.9" (10 cm) from a wall and 39.4" (100 cm) from the top.

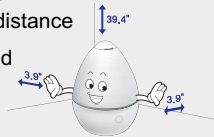

Avoid humidifier's mist from directly contacting furniture, TV, gas range, etc.

According to water quality white powder may accumulate on surrounding furniture or TV due to calcium or magnesium dissolved in the water and the flame of the gas range may be affected.



Avoid your feet, hands or other objects from tripping on the power cord and the appliance from falling.

Doing so may cause bodily injury, property damage and leakage.



Do not install the appliance on a home appliance such as a TV.

The home appliance may be damaged by the mist.



Precaution

Instructions to protect owner's safety and prevent property damage.
Please read and save all instructions before use.



In use



Danger

Do not put pins, needles or foreign objects into the mist outlet of the humidifier and the seam of the appliance.

Doing so may cause bodily injury by electronic shock or abnormal operation.



Do not disassemble the mist outlet while operating and, especially, prevent children from touching it with their hands or faces.

Doing so may cause bodily injury.

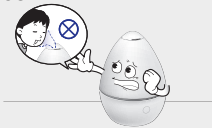

Supply clean water with normal temperature (between 42.8°F (6°C) and 95°F (35°C)) to the water tank.

Failure to do so may cause damage of the appliance or nebulizer.

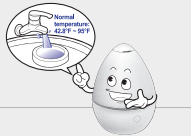

Do not block the mist outlet with a towel or hand while operating the appliance.

Doing so may cause appliance failure, fire, burn or leakage.



Do not scratch the nebulizer surface with fingers or a sharp implement.

Doing so may cause appliance malfunction.

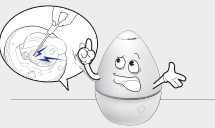

Do not disassemble the tank or move the appliance while operating.

Doing so may cause appliance malfunction, electric shock, leakage, fire or burn.



Do not apply strong impact while carrying the water tank for top-up or cleaning.

Doing so may cause leakage or appliance damage by the impact and dropping the tank may cause injury on the instep of a foot or other body part.

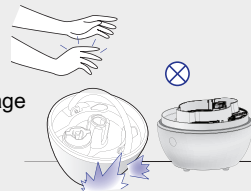



Warning

Do not directly inhale the humidity.

Doing so may damage your health.

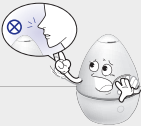

Do not leave volatile materials (insecticide, gasoline, thinner, benzene, etc.) on the top of or near the appliance.

Doing so may cause deterioration, discoloration and fire.



When draining for appliance cleaning, incline the appliance in the drain direction to avoid the water from being entered the vent. Wait until the water gets cold before draining.

Failure to do so may cause electric shock or appliance damage.

※ Remove the water in the water tank only after unplugging the power cord.



Do not use organic solvents such as spray-type insecticide, gasoline, thinner and benzene for cleaning the appliance.

The use of organic solvents may cause deterioration, discoloration or bodily injury.

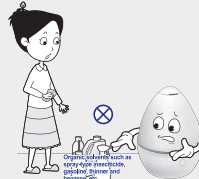

Do not put a thick cloth or towel on the bottom of the main body.

Doing so may cause appliance damage.



Do not disassemble, repair or tamper with the appliance arbitrarily.

Doing so may cause electric shock, fire or appliance damage.



Do not allow a child to use the appliance by itself. Keep the appliance out of the reach of children.

Doing so may cause electric shock, burn or bodily injury.



Precaution

Instructions to protect owner's safety and prevent property damage.
Please read and save all instructions before use.



In use



Caution

If the appliance is not to be used for a long time, remove the water in the water tank or reservoir thoroughly before storing.

The remaining water may cause nebulizer damage, malfunction or pollution.



When using in Turbo mode for a long time, the flow may get wet.

※ Change the Humidification mode into Rhythm or Weak mode to lower the spraying amount.

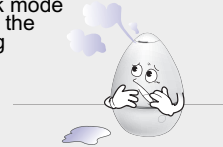

To use the appliance after long-term storage, wash the water tank, reservoir and filter before using.

There is a danger of propagation or creation of germs or foreign materials after long-term storage.

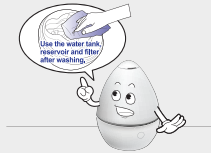

Caution

Assemble the water tank cap after aligning the open/close mark to the bottom of the tank. Incomplete locking of the water tank cap may result in appliance leakage.

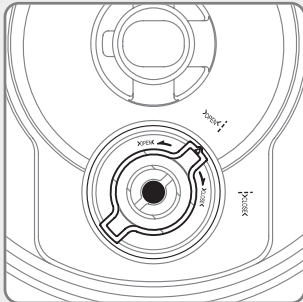

<Open Status>

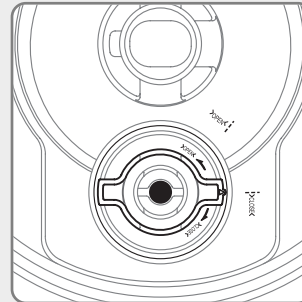

<Close Status>



Precaution

Features

1 Silicon Nebulizer Cap

A silicon nebulizer cap is applied to the fitted to the nebulizer to prevent foreign materials from being generated.



2 Soft Water Tank Cap

A consumer can open/close the water tank cap using minimal force.

- ▲ Close the cap after aligning the Open/Close marks to the tank cap mark (▲).

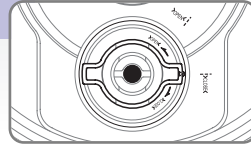

3 Empty Indicator Function

If the water in the water tank is empty, the water empty indicator (red LED) on the display window is turned on along with "No-Water" melody.



4 Soft Touch Button

A soft touch button is applied to enhance operation ability.



5 Rhythm Humidification Function

The function automatically adjusts the mist amount to create the optimal indoor environment. If you press the button again, the mode changes into Turbo mode.



6 Antibacterial Ceramic Filter

Using a filter composed of nano-silver material and a ceramic ball enhances the antibacterial ability.

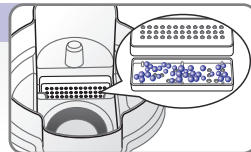

7 Air-Cleaning Filter

The filter sucks the exterior air of the purifier and purifies it into clean air.

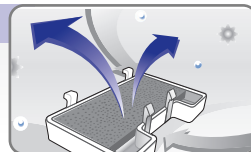

Parts descriptions

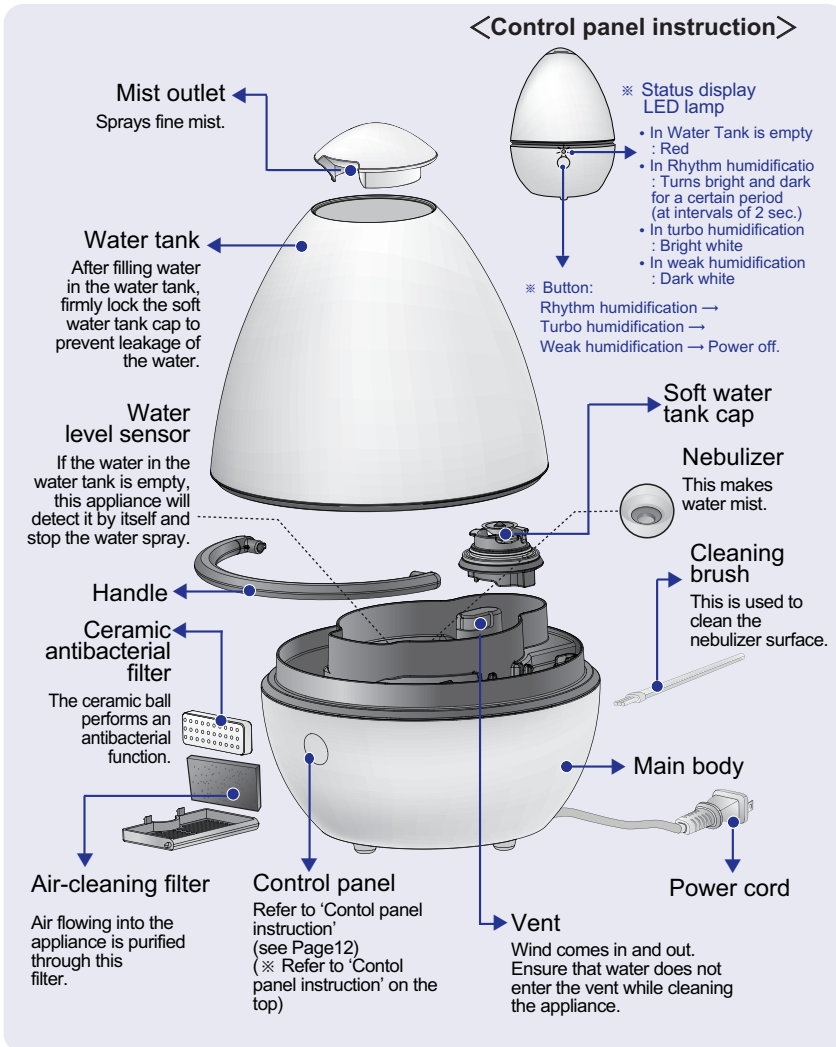

Direction for use

- ⚠ Fill with water before plugging the power cord.
(No water may cause nebulizer malfunction.)
- ⚠ Coins, nails and screws in the reservoir result in the malfunction of the nebulizer part. Please check before starting. In addition, disconnect the water tank, drain the water in the reservoir thoroughly and check if the air-cleaning filter is mounted on the bottom of the appliance.
- ⚠ After initially filling with the water, the humidification starts after approx. 1minutes.
Wash the water tank before initial use to spray more comfortable mist.

Filling the water tank

- 1 Detach the mist outlet and lift out the water tank.
Lift out the water tank by using the handle on the lower water tank.
※ If the water tank is carried with the mist outlet attached, the appliance may be damaged by twisting of the mist outlet.

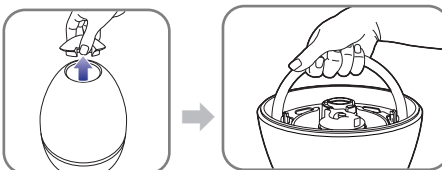

- 2 Turn the soft water tank cap anti-clockwise to open the cap.

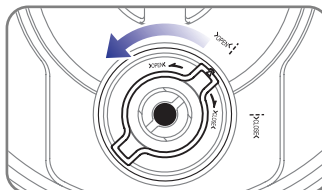

- 3 Fill water in the water tank.
 - Use clean tap water.
 - ※ Do not use cold water below 42.8°F (6°C) and warm water above 95°F (35 °C)
Doing so may cause nebulizer malfunction.
 - ※ The use of underground water or water with a lot of rust or dregs may cause weak mist output or appliance failure.
 - After topping up with water, dry the water tank with a clean cloth.

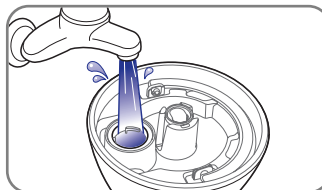

- 4 Turn the soft cap clockwise until the cap is closed thoroughly.
※ Close the cap after aligning the 'Close' mark to the cap mark and the bottom mark of the tank.

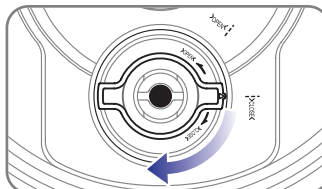

- 5 Fit the mist outlet in the water tank so it faces the front of the appliance for spraying.

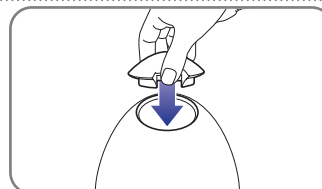

Direction for use

- Insert the power cord in a 120 V~ socket and press the soft touch button. The appliance will start with bell sound.
 - The default setting of the appliance is (rhythm humidification).
 - After inserting the plug, make the indoor environment comfortable by following the instructions for operation.
 - If the appliance is not used, unplug the power cord and store the appliance.

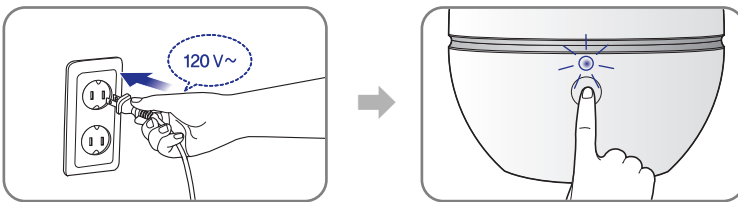

- The use of the water fully cooled after boiling or tap water stored for a day will provide more comfortable humidity.
- If the appliance is not to be used for a long time, remove the water in the water tank and the reservoir thoroughly.
- **The humidity has a bad smell:** The smell comes from chlorine contained in tap water. Using tap water stored for a day or water fully cooled after boiling will reduce the smell.
- **Weak mist output or no mist output:** The appliance may have a weak mist output when cold water is used or water level is high. Operate the appliance in strong mode for 30 seconds and then the appliance will operate normally.
- **No mist output after cleaning:** Foreign materials remain on the nebulizer. Wash out the inside of the reservoir and the water tank with clean water and wipe the surface of the nebulizer with a clean brush.
- In 'Weak' mode, a small amount of invisible water mist is sprayed but the operation is normal.



Control panel instruction

How to use the buttons on your appliance

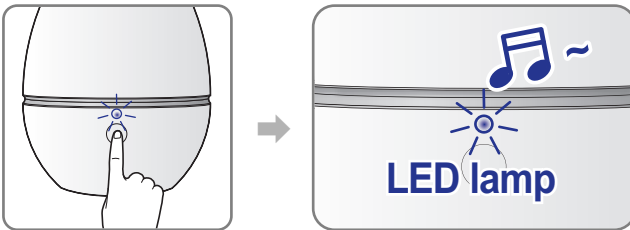

	Melody	Status (LED lamp)
Power	Ring ("Mi" sound)	Power-off
Rhythm humidification	"Do-Re-Mi" sound	Blinks in a given period. (at intervals of 2 seconds)
Turbo humidification	"Mi-Sol" sound	Bright white
Weak humidification	"Mi-Do" sound	Dark white
Off	"Mi" sound	Power-off

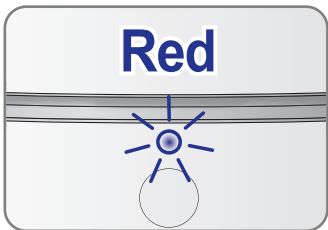

※ **Empty indicator :**
When water is empty,
the red lamp is turned
on along with melody.
Use the appliance
after water top-up.



※ With the single soft touch button on the bottom front of the appliance, you can select Rhythm mode (power-on) → Turbo mode → Weak mode → Power-off.

Maintenance

- ⚠ Unplug the power cord before cleaning.
- ⚠ Clean the reservoir and the water tank once per two days.

1 Cleaning the water tank

- Put tap water in the water tank, wipe it with a soft cloth and shake the water tank to remove water scale.

- ※ Do not use general detergent or soapy water. Doing so may cause nebulizer damage or bodily injury as they are sprayed along with water mist.

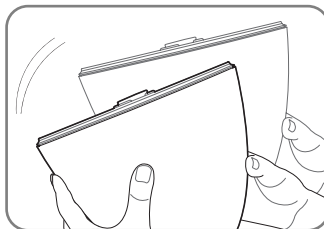

2 Cleaning the main body

① Drain the water in the body.

- ※ Drain the water in drain direction.
- ※ Ensure that water does not enter the vent.
- ※ Do not disassemble the water level sensor. Doing so may cause appliance failure.

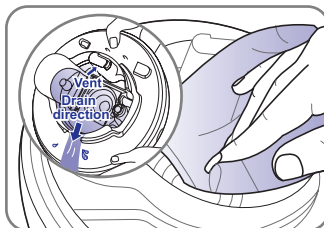

3 Cleaning the mist guiding pipe

- Wash out the pipe with clean water and remove water scale with a soft cloth.

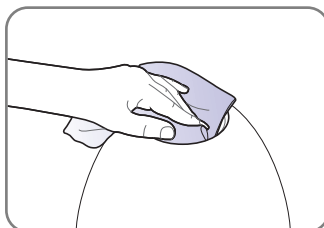

4 Cleaning the mist outlet

- After separating the mist outlet, wash out it with clean water and remove water scale with a soft cloth.

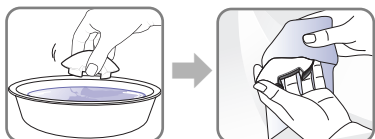



Maintenance

Precaution

5 Cleaning the air-cleaning filter

- Pull out the filter cover by pressing it slightly, remove the filter dust with running water and then attach it again after drying thoroughly.

Clean the filter weekly to maintain comfortable air.

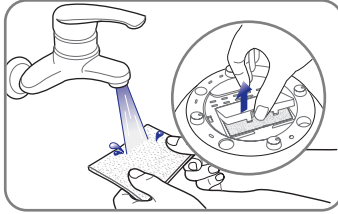

6 Cleaning the nebulizer

- Wipe the surface of the nebulizer with a soft brush and clean softly and dry the nebulizer with a soft cloth.

- The water scale(white powder phenomenon) on the nebulizer surface will make the mist weak.
- ※ Do not wipe the nebulizer with general detergent or soapy water. The mist may become weak or the nebulizer may be damaged.
- ※ Do not touch the nebulizer surface with fingers or scratch with a sharp implement. The mist may become weak or the appliance may malfunction.

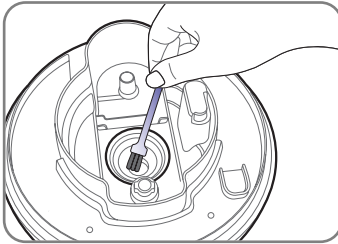

How to use



- The nebulizer is the consumable part and its lifetime is approx. 5,000 hours in standard operation condition.

● Long-term storage

- Remove the remaining moisture in the water tank, reservoir and mist outlet thoroughly with a soft cloth and then store the appliance.

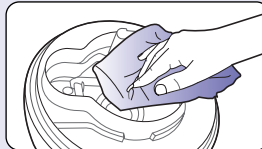

Troubleshooting

Troubleshooting guide

Before requesting repair service, check the following list.

Even if the appliance is not out of order, the humidifier may not operate normally because you are unfamiliar with the appliance or because of a minor problem. In these cases, the following list will help you fix the problem without the help of customer service. If the trouble continues, contact our customer service.

Problem	Solution
White dust is forming on the nebulizer water tank.	<ul style="list-style-type: none"> • Fine materials on the nebulizer space and reservoir are harmless. • Use the appliance after cleaning the nebulizer with clean water.
Air blows but water vapor is not produced.	<ul style="list-style-type: none"> • Check if the spray is in 'weak' mode. • If underground water has been used, replace it with tap water. • Clean the nebulizer and its surrounding area. • If the water level in the reservoir is high, drain some water.
Humidity Level is low.	<ul style="list-style-type: none"> • If underground water has been used, replace it with tap water. • Is the water in the appliance hot, cold or frozen? (The use of water below 42.8°F (6°C) or above 95°F (35°C) may cause nebulizer failure.) • If the spray amount gets too small, remove the foreign materials on the nebulizer surface. • Is the nebulizer damaged or is the lifetime of the nebulizer expired? (The nebulizer is a consumable part.)
The humidity has a bad smell.	<ul style="list-style-type: none"> • The smell comes from chlorine contained in tap water and is harmless. (Use tap water stored for a day or water fully cooled after boiling will reduce the smell.) • Clean the inside of the appliance.
Water supply is not consistent.	<ul style="list-style-type: none"> • Put the water tank on the body correctly. • Fill with water to more than half the water tank.
The floor is too wet.	<ul style="list-style-type: none"> • Reduce the mist amount.

※ Coway Customer Service Center : (213) 386 -3033

Appliance Specifications

Model Number	MHS-U2201AX
Power Supply	120 V~, 60 Hz
Power Consumption	25 W
Humidifying Mod	Ultra-sonic type
Max. Humidity Amount	50 mgal/hr (190 mL/hr) (based onTurbo humidification)
Successive Humidity Hours	Approx. 20 hours (based on rhythm humidification)
Weight	4.4 lbs. (2.0 kg)
Water tank capacity	0.5 gal (2.0 L)
Dimensions	8.2"(W) X 8.2"(D) X 11.4"(H) 208(W) X 208(D) X 290(H) mm

※ These specifications may be slightly changed for the enhancement of appliance performance.

Precaution

How to use

Troubleshooting

코웨이 고객 여러분께

코웨이 가습기를 구입해 주셔서 감사드립니다. 제품의 올바른 사용과 유지를 위해 본 사용설명서를 잘 숙지하시고 보관하시어 고객 여러분께 많은 도움이 되시길 바랍니다. 본 제품 사용 중 기능이 제대로 작동하지 않거나 의문사항이 발생했을 때 참고하시길 바라며, 아울러 본 제품 사용설명서의 사용방법을 따르지 않아 발생한 사고는 당사에서 책임지지 않습니다.

사용전 알아두기

안전을 위한 주의사항	18
코웨이 가습기의 특징점	24

사용방법

제품 각 부분의 명칭	25
사용준비	26
사용방법	28
청소방법	29

자가진단

A/S를 요청하시기 전에	31
제품규격	32



사용전 알아두기

안전을 위한 주의사항

사용자의 안전을 지키고 재산상의 손해를 막기 위한 내용입니다.
주의사항을 잘 읽고 올바르게 사용해 주십시오.



지시한 내용이 지켜지지 않으면 사망 또는 중대한 상해가 예상되는 경우



지시한 내용이 지켜지지 않으면 상당한 신체 상해 또는 물적 손해가 예상되는 경우



지시한 내용이 지켜지지 않으면 경미한 신체 상해 또는 물적 손해가 예상되는 경우



전원관련



본 제품은 120 V~ 전용입니다.
감전, 화재의 위험이 있습니다.

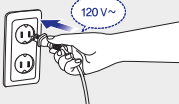

손상된 전원플러그나 헐거운 콘센트는 사용하지 마십시오.

감전, 화재의 위험이 있습니다.

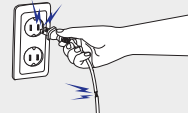

젖은 손으로 전원 플러그를 만지지 마십시오.

감전, 화재의 위험이 있습니다.



제품 이동시 전원선을 당겨서 이동하지 마십시오.

감전, 화재의 위험이 있습니다.



전원플러그에 묻은 이물질은 깨끗이 제거하여 주십시오.

고장, 화재, 감전의 원인이 됩니다.

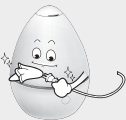

전원선을 임의로 연결하거나 가공하여 사용하지 마십시오.

감전의 위험이 있습니다.





사용전 알아두기

사용자의 안전을 지키고 재산상의 손해를 막기 위한 내용입니다.
주의사항을 잘 읽고 올바르게 사용애 주십시오.



전원관련



위험

전원플러그를 연속하여 꽂았다 빼지 마십시오.

감전, 화재의 위험이 있습니다.

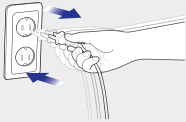

전원코드나 전원플러그가 파손된 경우 그 제조자나 판매점 또는 유자격 기술자(서비스 기사)에 의해 교환 또는 수리하십시오.

감전, 화재의 위험이 있습니다.

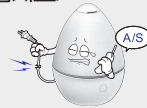

전원선을 무리하게 구부리거나 무거운 물건에 눌러 훼손, 변형되지 않도록 하십시오.

감전, 화재의 위험이 있습니다.



전원 부분에 물이 들어간 경우 전원플러그를 빼고 완전히 건조시킨 후 사용하십시오.

감전, 화재의 위험이 있습니다.



전원플러그를 뺄 때는 플러그를 잡고 빼주십시오.

코드선을 잡고 빼면 심선의 일부가 단선 되어 발열, 발화의 원인이 됩니다.



제품 수리나 점검, 제품 청소 및 부품 교환시 반드시 전원플러그를 빼주십시오.

감전의 위험이 있습니다.

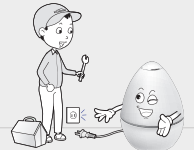

한 콘센트에 여러 전기제품을 동시에 꽂아 사용하지 마시고 전용 콘센트를 사용하십시오.

발열 및 발화, 감전, 화재의 위험이 있습니다.

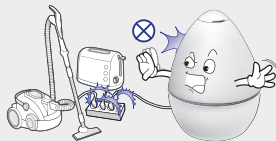



설치관련



어린이 손이 닿을 수 있는 곳에서 사용하지 마십시오.

감전, 화재, 화상의 원인이 됩니다.

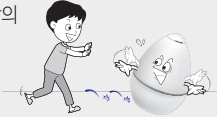

파손된 물통을 사용하지 마십시오

감전, 화재, 누수의 원인이 됩니다.



직사광선이 쬐는 곳은 피해 설치하시고, 열기구와 가까운 곳에 설치하거나 촛불, 담뱃불 등을 제품 위에 올려 놓지 마십시오.

화재의 위험이 있습니다.

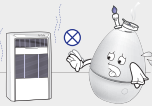

습기, 먼지가 많은 곳, 물뿔물이 튀는 곳에는 설치하지 마십시오.

감전, 화재의 위험이 있습니다.



제품을 유리 위에서 사용하지 마십시오.

유리표면에 물방울이 맺혀 제품이 미끄러져 파손 및 화상의 우려가 있습니다.



주의

경사진 곳에 제품을 설치하지 마시고, 제품에 무리하게 힘을 가하거나 충격을 주지 마십시오.

신체 상해 및 제품 파손 및 누수의 우려가 있습니다.

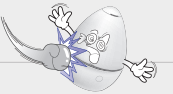

벽면에 가깝게 놓고 사용하지 마십시오.

벽면과 3.9"(10 cm), 윗면과 39.4"(100 cm) 이상 거리를 두십시오.



가습기의 분무입자가 가구, 텔레비전, 가스렌지 등에 직접 닿지 않게 설치하십시오.

수질에 따라 물속에 포함되어 있는 칼슘이나 마그네슘 등에 의해 주위의 가구, 텔레비전 등에 하얀 분말이 생길수도 있으며 가스렌지의 불꽃이 변할 수도 있습니다.



전원코드에 손이나 발, 기타 물체가 걸려 제품이 떨어지지 않도록 주의해 주십시오.

신체 상해 및 제품 파손 및 누수의 우려가 있습니다.

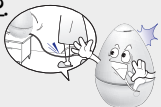

제품을 텔레비전 등의 가전제품 위에서 사용하지 마십시오.

분무 입자에 의해 가전 제품의 고장이 발생될 수 있습니다.



사용전 알아두기

사용자의 안전을 지키고 재산상의 손해를 막기 위한 내용입니다.
주의사항을 잘 읽고 올바르게 사용애 주십시오.



사용중에



위험

가습 분무구 및 제품의 이음새에
핀이나 바늘, 기타 이물질 등을
넣지 마십시오.

감전과 이상작동으로
상해를 입을 수도
있습니다.

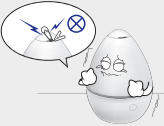

제품 작동중 가습 분무구를 분리하
지 마시고, 특히 아이가 손이나 얼
굴을 갖다 대지 못하게 하십시오.

상해의 위험이
있습니다.



물통에 반드시 상온(42.8°F (6
°C) 이상 95°F(35 °C) 이하)의 깨끗한 물을 공급하십시오.

진동자 및 제품
파손의 우려가
있습니다.



제품 동작 시에 가습 분무구를
수건이나 손으로 막지
마십시오.

제품 고장 및 화재,
화상, 누수 등의
원인이 됩니다.



손가락이나, 날카로운 물건 등으로
진동자 표면을 긁지 마십시오.

제품 고장의
원인이 됩니다.

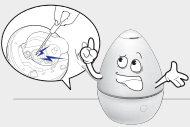

제품 동작 시에 물통을 분리하거나,
제품을 운반하지 마십시오.

고장이 발생하거나
감전, 누수, 화재,
화상 등의
위험이 있습니다.



물탱크의 물보충 혹은 청소를 위한 운반 시에
강한 충격을 피해 주십시오.

충격으로 인한 누수 및 제품 파손 위험이 있으며,
낙하 시에 발등 및 기타 신체부위에 상해를 입을
수 있으므로 주의하십시오.





경고

분무되는 물입자를 흡입하지 마십시오.

건강에 나쁜 영향을 끼칠 우려가 있습니다.

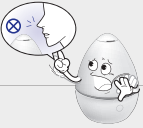

휘발성 물질(살충제, 휘발유, 신나, 벤젠 등)을 제품 상측 혹은 주변에 두지 마십시오.

변질, 변색 및 화재의 위험이 있습니다.



제품 청소를 위한 배수 시에 수조의 물이 충분히 식을 때까지 기다린 후, 송풍구에 물이 들어가지 않도록 반드시 배수 방향으로 제품을 기울여 물을 버려 주십시오.

감전 및 제품 파손의 원인이 됩니다.



※반드시 파워코드를 콘센트에서 뽑은 뒤 수조부 물을 제거해 주세요.

분무식 살충제, 휘발유, 시너(신나), 벤젠 등 유기용제를 사용하여 제품을 청소하지 마십시오.

변질, 변색 및 신체 상해의 원인이 됩니다.

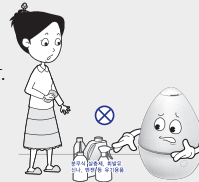

뚜껑은 천이나 수건을 본체 바닥 면에 놓지 마십시오.

제품 파손의 우려가 있습니다.



제품을 임의로 분해하거나 수리, 개조하지 마십시오.

감전, 화재, 제품 훼손의 위험이 있습니다.



어린이가 혼자 사용하거나 어린이가 만질 수 있는 장소에 제품을 두지 마십시오.

감전, 화상, 신체 상해의 위험이 있습니다.



사용전 알아두기

사용자의 안전을 지키고 재산상의 손해를 막기 위한 내용입니다.
주의사항을 잘 읽고 올바르게 사용에 주십시오.

사용중에



주의

장기간 사용하지 않을 시에는 수조부 및 물통 내부의 물을 완전히 제거하고 보관하십시오.

진동자가 손상되거나 고장 및 오염의 원인이 됩니다.



주위환경이 습하거나 장시간 TURBO 모드 사용시 바닥이 젖을 수 있습니다.

※ 기습모드를 리듬기습 또는 약기습으로 바꿔 분무량을 낮춰주시기 바랍니다.



장시간 보관후 사용하실 때는 수조부 및 물통, 필터를 세척한 후 사용하십시오.

장시간 보관 시 세균, 이물질 등의 번식, 생성이 우려됩니다.



수조부 및 물통 필터를 세척후 사용



주의

물통 캡 조립시 탱크 바닥면에 열림, 닫힘 표기부에 맞추어 조립해 주세요. 불안전하게 잠긴 물통캡은 제품 누수의 원인이 됩니다.

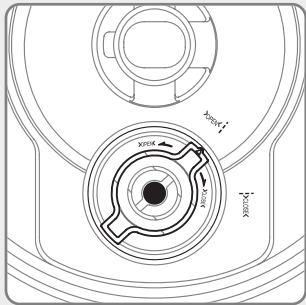

<열린상태>

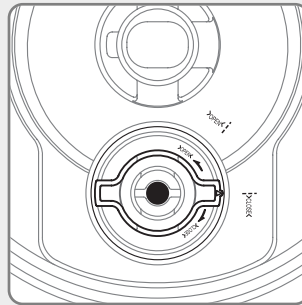

<닫힌상태>



사용전 알아두기

코웨이 가습기의 특징점

1 실리콘 진동자 캡

진동자에 실리콘 진동자 캡을 적용하여 이물질 발생을 방지하여 줍니다.



2 Soft 물통 캡

소비자가 적은 힘으로도 물통 캡을 여닫을 수 있습니다.

⚠ Open (열림), Close (닫힘) 표시부와 탱크캡 표시부 (▲)에 맞추어서 닫아주세요.

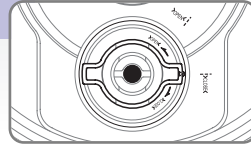

3 물보충 알림 기능

물통의 물이 부족하게 되면 물 없음 멜로디와 함께 표시창에 물보충 알림 표시(붉은색 LED 표시)가 들어옵니다.



4 소프트 터치 버튼

소프트 터치 버튼 적용으로 조작성을 향상시켰습니다.



5 리듬 가습 기능

분무량을 자동으로 강약을 조절하여 최적의 실내환경을 만들어 줍니다. 버튼을 한번 더 누르면 터보모드로 변경됩니다.



6 세라믹 항균 필터

은나노 소재의 필터에 세라믹 볼을 사용하여 항균력을 한층 향상 시켰습니다.

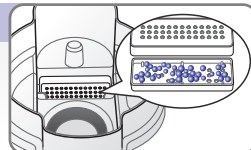

7 청정 항균 필터

가습기 외부의 공기를 흡입하여 깨끗한 공기로 정화시켜 줍니다.

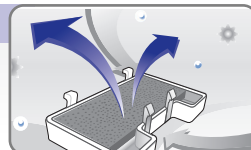

제품 각 부분의 명칭

외부/내부 명칭

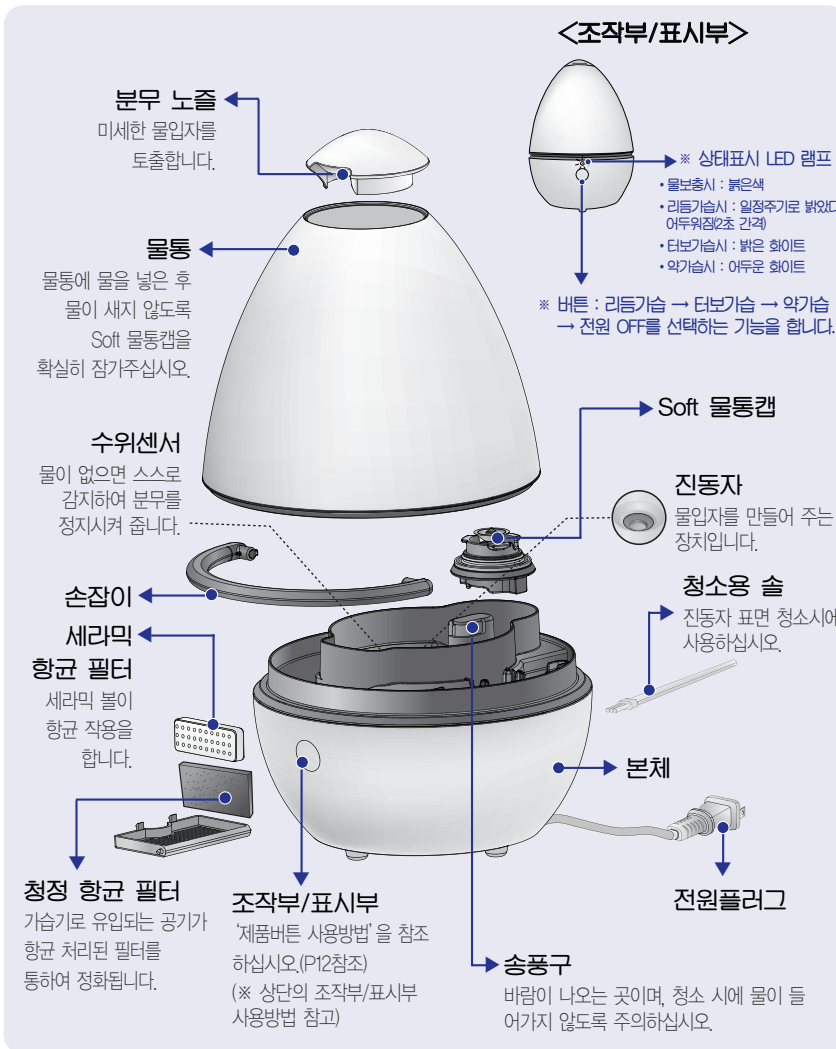

사용준비

- ⚠ 전원플러그를 꽂기 전에 먼저 물을 넣어 주십시오.(물을 넣지 않으면 진동자 고장의 원인이 됩니다.)
- ⚠ 동전이나 못, 나사등이 수조 내부에 들어가면 진동부 고장의 원인이 되므로, 사용하기기 전에 확인하여 주십시오. 또한, 물통을 분리하고, 수조내의 물을 완전히 배수 후, 제품 밑면에 기능성 청정필터가 있는지 확인하여 주십시오.
- ⚠ 처음 물을 넣으면 약 1분 정도 경과 후부터 가습이 시작됩니다.
처음 사용시 물통을 깨끗이 세척하고 사용하시면, 더욱 쾌적한 물입자가 토출됩니다.

하부 물투입구를 통하여 물을 공급할 경우

- 1** 가습 분무구를 분리 하여 물통을 들어 주십시오.

물통하부의 물통 손잡이를 이용하여 물통을 들어 주십시오.

※ 가습 분무구를 분리하지 않고 물통 운반시 노즐이 이탈되어 파손의 우려가 있습니다.

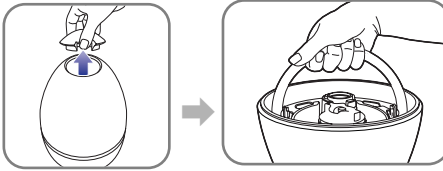

- 2** Soft 물통캡을 반시계 방향으로 돌려서 열어 주십시오.

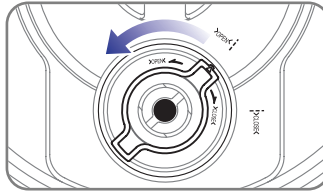

- 3** 물통에 물을 넣어 주십시오.

- 깨끗한 수도물을 사용하십시오.
- ※ 42.8°F(6°C)이하의 냉수와 95°F(35°C)이상의 온수는 사용하지 마십시오. 진동자 고장의 원인이 됩니다.
- ※ 수도물이 아닌 지하수, 녹 또는 찌꺼기가 많이 함유된 물을 사용하면, 가습량이 줄고, 제품 고장의 원인이 됩니다.
- 물 보충 후 물통에 묻어있는 물기를 깨끗한 천으로 닦아 주십시오.

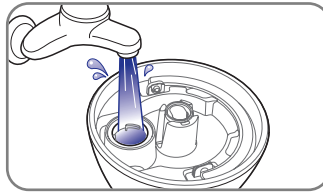

- 4** Soft 물통캡을 시계 방향으로 돌려서 닫아 주십시오.

※ 물통캡 표시부와 물통 바닥면 표시부에 닫힘부(Close)를 맞추어 닫아주세요.

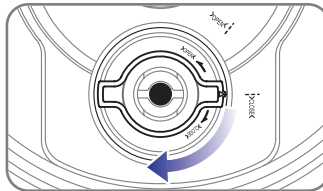

- 5** 가습 분무구를 제품의 전면을 향하여 분무가 될 수 있도록 하여 물통에 결합시켜 주십시오.

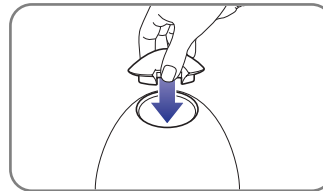

사용준비

- 전원플러그를 120 V~ 전용 콘센트에 꽂고, 소프트 터치버튼을 누르면 벨소리와 함께 작동됩니다.

- 초기 설정은 (리듬가습)으로 되어 있습니다.
- 플러그를 꽂은 후 조작부 사용방법에 따라 쾌적한 실내환경을 만드십시오.
- 사용하지 않을 경우, 플러그를 빼서 보관하십시오.

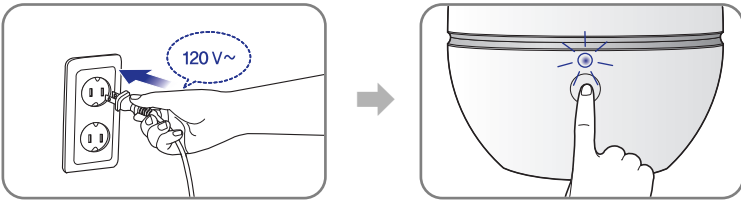

- 끓였다 완전히 식힌 물, 하루정도 받아 보관한 수돗물을 사용하시면 더욱 쾌적한 습기를 얻을 수 있습니다.
- 장기간 사용하지 않을 때는 물통 및 저수조의 물을 완전히 제거해 주십시오.
- 분무되는 물입자에서 냄새가 날 때 : 이것은 수돗물에 함유되어 있는 염소에서 나는 냄새로 하루이상 지난 수돗물이나, 끓였다 완전히 식힌 물을 사용하시면 냄새가 줄어듭니다.
- 분무가 약하거나 안될 때 : 차가운 물이나 수위가 높아졌을 때, 분무가 약한 경우가 있습니다. 강으로 30초 정도 동작시키면 정상적으로 작동됩니다.
- 청소후 분무가 안될 때 : 진동자에 이물질이 묻어 있습니다. 깨끗한 물로 저수조 및 물통 내부를 행구고, 제공된 청소용 솔을 이용하여 진동자 표면을 닦고 사용하십시오.
- '약 모드'에서는 적은 양이 분무되어, 육안으로 감지하기 어렵지만 작동에는 이상이 없습니다.



사용방법

알아두기

‘제품 버튼’ 사용방법

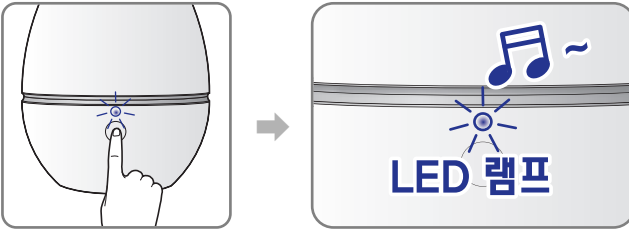

	멜로디	상태표시 (LED 램프)
전 원	땡(미)	꺼짐
리듬기습	띠리링(도레미)	일정주기로 밝았다 어두워짐(2초간격)
터보기습	띠링(미솔)	밝은 화이트
약 가습	띠딩(미도)	어두운 화이트
OFF	땡(미)	꺼짐

사용방법



※ 물보충 표시 :
 물이 없을 때 멜로디와 함께
 붉은색 램프가 켜집니다.
 물 보충 후 사용해 주세요.



※ 제품 전면 하단부의 소프트 터치버튼 하나로 리듬기습(꺼짐) → 터보기습 → 약기습
 → 꺼짐 조절이 가능합니다.

저가전단

청소방법

- ⚠ 청소하기 전에 전원플러그를 반드시 빼주십시오.
- ⚠ 수조부 및 물통은 2일 1회 이상 청소하여 주십시오.

1 물통 청소방법

- 수돗물을 물통 내부에 넣고 부드러운 헝겊으로 닦은 후, 물통을 흔들어 물때를 제거하십시오.

※ 일반세제나 비눗물을 사용하여 청소하지 마십시오.
진동자 손상의 원인 및 가슴입자와 함께 토출되어 인체 상해의 원인이 될 수 있습니다.

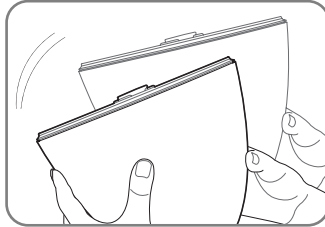

2 본체 청소방법

① 본체 내부의 물을 버려 주십시오.

- ※ 배수 방향으로 물을 버려 주십시오.
- ※ 송풍구 내로 물이 유입되지 않도록 주의 하십시오.
- ※ 수위센서를 분해하면 제품 고장의 원인이 되므로, 분해하지 마십시오.

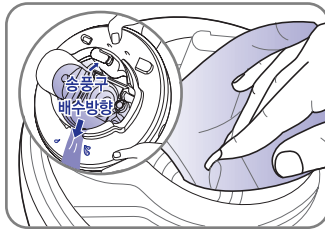

3 분무안내관 청소방법

- 깨끗한 물로 헹궈 주신 후, 부드러운 헝겊으로 물때를 제거하십시오.

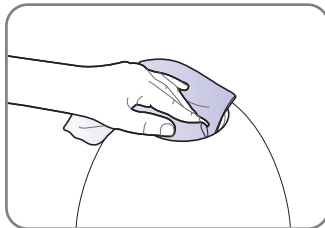

4 가슴 분무구 청소방법

- 분무 노즐을 제품에서 분리하고 깨끗한 물로 헹궈주신 후 부드러운 헝겊으로 물때를 제거하십시오.

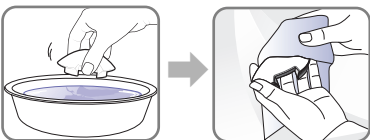

청소방법



알아두기

5 청정 항균 필터 청소방법

- 필터커버를 가볍게 눌러 당기듯이 빼내어, 필터를 분리 하시고 필터의 먼지를 흐르는 물로 청소하고 깨끗이 건조 후에 장착하십시오

주 1회 이상 청소하면 쾌적한 공기를 유지시켜 줍니다.

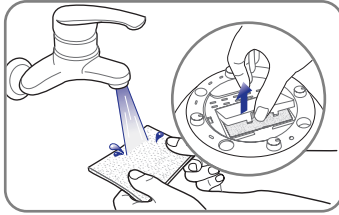

6 진동자 청소방법

- 제공된 청소용 솔을 이용하여 진동자 표면을 부드럽게 닦아내고, 부드러운 헝겊을 이용하여 주변의 물때를 깨끗이 닦아 주십시오.

- 진동자 표면에 물때(백분현상)가 끼면 분무가 약해집니다.
- ※ 일반세제나 비누물로 진동자를 닦지 마십시오. 분무가 약해지거나 진동자가 손상됩니다.
- ※ 진동자 표면을 손가락으로 문지르거나, 날카로운 물건으로 긁으면 분무가 약해지거나 고장의 원인이 됩니다.

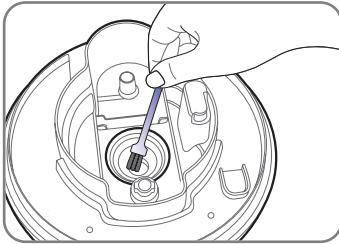

사용방법



- 진동자는 소모품이며, 수명은 표준 사용 조건에서 약 5,000 시간입니다.
- 장시간 보관 시
 - 부드러운 헝겊으로 물통 및 노즐, 수조부 등에 남아있는 물기를 완전히 제거한 후 보관하십시오.

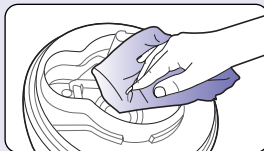

지기전단

A/S를 요청하시기 전에...

A/S를 요청하시기 전에 아래의 사항을 확인해 주십시오.

제품의 고장은 아니지만 사용법에 익숙하지 않거나 사소한 원인으로 가습기가 정상적으로 작동하지 않을 수가 있습니다. 이런 때에는 다음의 사항에 대해 점검하신다면 서비스 센터의 도움 없이도 간단한 문제는 해결할 수 있습니다. 아래의 항목에 대해 점검하시고도 문제가 해결되지 않으면 서비스 센터로 문의해 주십시오.

현 상	조 치 방 법
진동자 수조부에 이물질이 생겨요.	<ul style="list-style-type: none"> 수조부에 발생한 미세 물질은 인체에 무해합니다. 깨끗한 물로 세척한 후 사용하십시오.
바람은 나오는데 물입자가 나오지 않아요.	<ul style="list-style-type: none"> 분무량이 "약"인지 확인하십시오. 지하수를 사용하셨다면 수돗물로 교체하십시오. 진동자 및 진동자 주변을 청소하십시오. 수조부의 물 수위가 높은 경우에는 물을 비운 후 사용해 주십시오.
가습량이 너무 작아요.	<ul style="list-style-type: none"> 지하수를 사용하셨다면 수돗물로 교체하십시오. 제품 내부의 물이 얼었거나, 너무 차가운 물 또는 뜨거운 물을 사용하셨나요? 42.8°F (6°C) 이하의 물이나 95°F (35°C) 이상의 온수는 진동자 고장의 원인이 됩니다.) 가습량이 약해졌을 시 진동자 표면의 이물질을 청소해 주십시오. 진동자가 손상되었거나 수명이 다하신 않았나요? (진동자는 소모품입니다.)
물입자에서 냄새가 나요.	<ul style="list-style-type: none"> 수돗물에 함유된 염소 성분의 냄새로 인체에는 무해합니다. (끓였다 완전히 식힌 물, 하루정도 지난 수돗물을 사용하시면 냄새가 줄어듭니다.) 제품 내부를 깨끗이 청소하십시오.
물공급이 원활하지 않아요.	<ul style="list-style-type: none"> 물통을 본체에 제대로 놓아 주십시오. 물통의 1/2이상 물을 넣어 주십시오.
바닥이 젖어 있어요.	<ul style="list-style-type: none"> 분무량을 낮춰 주십시오.

※ Coway Customer Service Center : (213) 386 - 3033

제품규격

제품명	MHS-U2201AX
정격전압 및 주파수	120 V~, 60 Hz
정격 소비전력	25 W
분무방식	초음파식
최대분무량	50 mgal/hr (190 mL/hr) (터보가습 기준)
연속분무시간	약20시간 (리듬가습 기준)
제품중량	4.4 lbs. (2.0 kg)
물통용량	0.5 gal (2.0 L)
제품크기	8.2"(W) X 8.2"(D) X 11.4"(H) 208(W) X 208(D) X 290(H) mm

※ 제품의 성능 개선을 위하여 약간의 규격변동이 있을 수 있습니다.